

## Dimensional Drawings

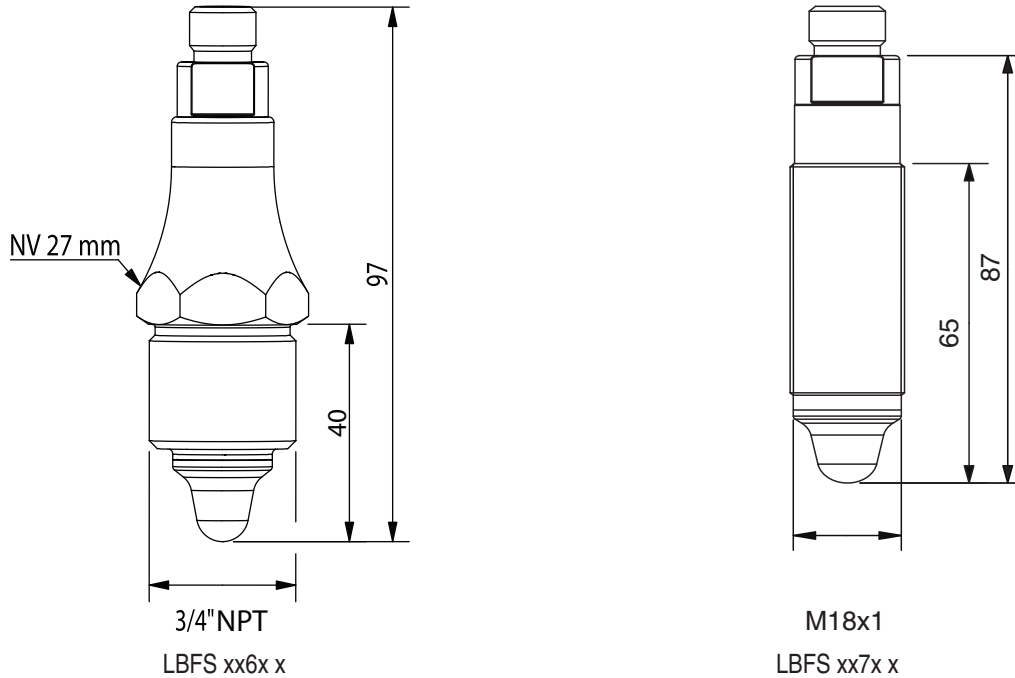

## Electrical Connection

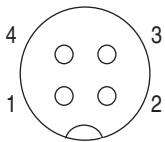

M12 plug	Cable	Function
1	Brown	+ VDC
2	White	Normally closed
3	Blue	- VDC
4	Black	Normally open

## Electrical Installation

### Normally Closed

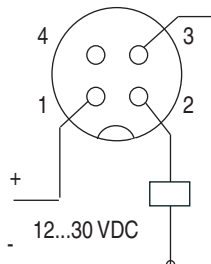
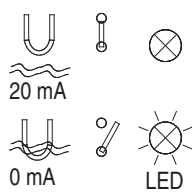

PNP Output  
20 mA max.

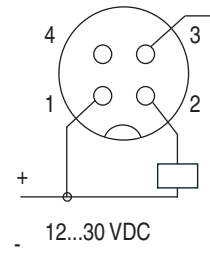

NPN Output  
20 mA max.

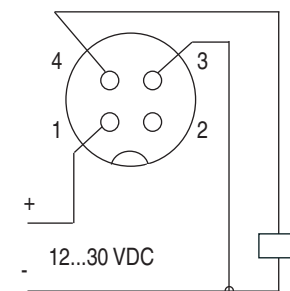
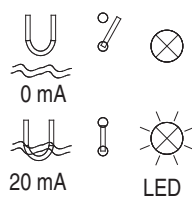

PNP Output  
20 mA max.

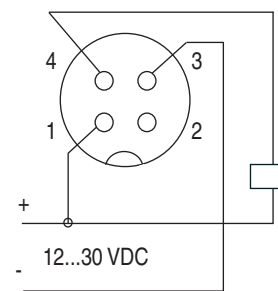

NPN Output  
20 mA max.

## Configuration

### FlexProgrammer 9701

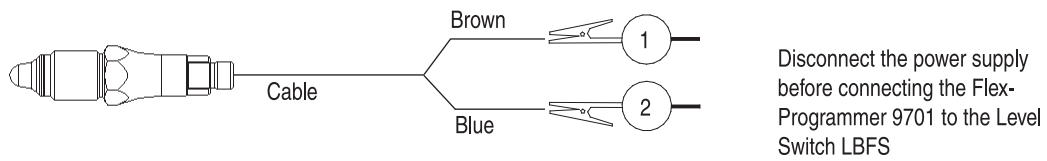

## Accessories

### FlexProgrammer 9701



The FlexProgrammer 9701 is a dedicated tool to configure Baumer configurable products

#### Type N° 9701-0001 comprises:

FlexProgrammer  
USB cable  
CD with the FlexProgram software

### Accessories examples

**LB020**



**CAM023**



ISO 2852 clamp

**VAM023**



Varivent

**PM023**



G½ hygienic welding sleeve in AISI 316

## Application

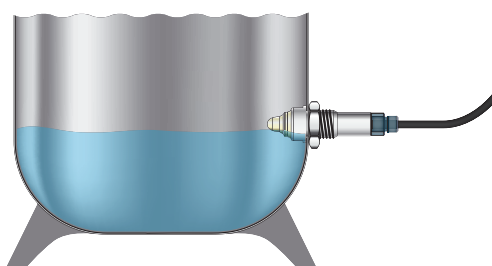

LBFS xx5x x

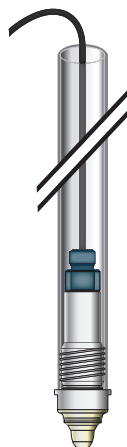

LBFS xx5x x